

Opravná sada II328090062

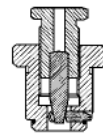
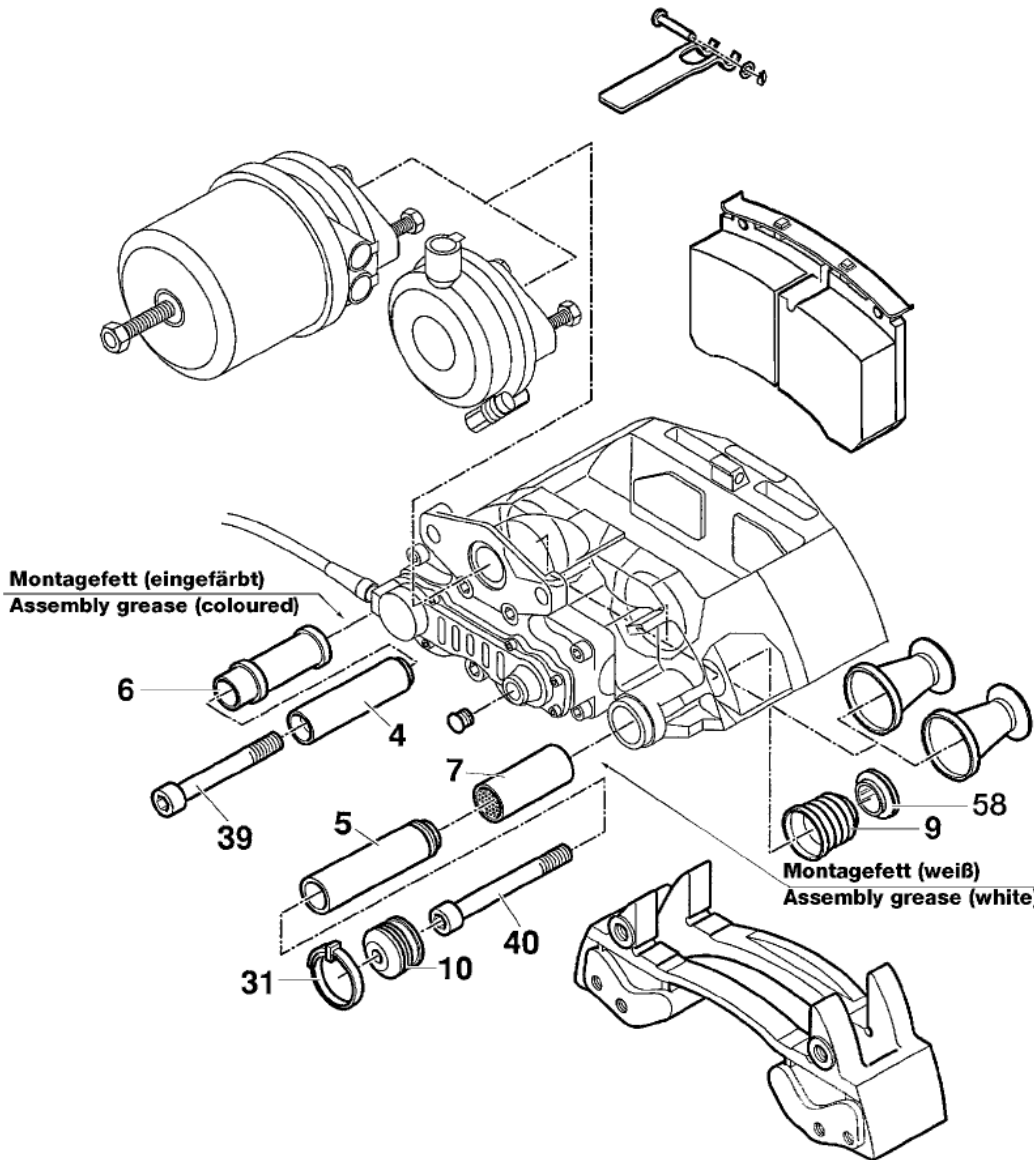

Nur bei Nut in
Sattelbohrung verwenden !
Use only if caliber hole
is grooved !

II 36797

Montagewerkzeug für Pos. } 7
Assembly tool for item

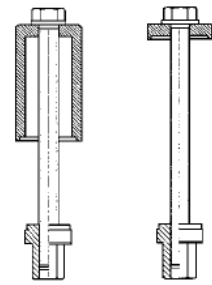

II 19254

Montagewerkzeug für Pos. } 7
Assembly tool for item



II 19253

Montagewerkzeug für Pos. } 9
Assembly tool for item